

# *Locator* **2**

Owners Manual



**HOCKING**

## Important notice

PLEASE READ THE FOLLOWING INFORMATION PRIOR TO USE OF ANY PRODUCT MANUFACTURED BY HOCKING NDT LTD.

Hocking NDT Operating Handbooks provide functional information about a particular instrument or group of instruments. However, proper set-up and use of this equipment and the performance of electromagnetic tests requires familiarity with factors which are beyond the scope of Operating Handbooks. These factors include the following:

- A. Selection of appropriate cables, probes, fixtures, mechanical handling equipment and other accessories.
- B. Selection of proper test frequency, test mode and other test settings.
- C. Preparation of the test surface.
- D. Characteristics of the test material for example: conductivity, hardness, permeability, geometry, magnetic properties, heat treatment etc.
- E. Environmental factors such as temperature humidity, dust and electrical interference.
- F. Any individual factors that will depend on the particular test object or test being performed.

It is therefore imperative that operators are properly trained in both general procedure for electromagnetic training testing and in the set up and execution of the particular test to be performed. It is the responsibility of the instrument user to ensure that test operators are trained to a sufficiently high standard, suitable equipment is used in the correct manner and that any test variables which may affect specific tests are taken into account. Similarly, compliance with standards such as ASTM, ASNT, API, ASME, BS etc., as well as the observance of

any test procedure specified by any government, manufacturer or other regulating authority is the responsibility of the user.

Periodic calibration, cleaning and maintenance may be necessary to ensure proper operation of the equipment. Environmental conditions and regularity of use should be considered when determining the frequency of such checks, then this should be observed.

Incidents such as physical shock, immersion in liquid and exposure to damaging environments such as excessive heat, moisture, dirt or dust can adversely affect equipment performance. The equipment must be examined for damage and recalibrated after any such incident. Do not use any product which you know or suspect to be faulty.

---

### EC Declaration of Conformity

We Hocking NDT Ltd  
Inspec House  
129-135 Camp Road  
St. Albans  
Hertfordshire  
AL1 5HP  
United Kingdom

declare under sole responsibility that the **Locator 2 Eddy Current Flaw Detector** meets the intent of Directive 89/336/EEC for Electromagnetic Compatibility.

Compliance was tested to:

EN 50081 - 1 Emissions  
EN 50082 - 1 Immunity

---

## Important notice (Cont.)

Reference samples used for calibration should, ideally, have the same material properties as the object to be tested, or a known relationship to it, established by a laboratory test.

Equipment calibration should be checked frequently during testing to assure valid test measurements. As a matter of good practice and wherever possible, suspected defects in critical areas should be cross checked using appropriate alternative indication techniques.

Any question about the use, operation, specifications or special considerations relative to the particular Hocking NDT product you are using should be addressed to your local sales representative, the distributor or Hocking direct.

Eddy current based instrumentation works by measuring minute electromagnetic fields. Interfering signals, even at a level satisfying CE mark requirements, may be able to mask or distort this information. The user is responsible for ensuring that no such effect is occurring.

Hocking NDT pursues a policy of continued development of its products. The company reserves the right to change specifications without prior notice.

## Contents

| <b>Chapter</b>   | <b>Title</b>                             | <b>Page</b> |
|------------------|--|-------------|
| <b>Chapter 1</b> | Unpacking and preparing for operation    | 7           |
| <b>Chapter 2</b> | Introduction to controls and basic setup | 9           |
| <b>Chapter 3</b> | Operation of Locator 2                   | 19          |
| <b>Chapter 4</b> | Power sources and battery management     | 37          |
| <b>Chapter 5</b> | SupervisorPC Lite (option)               | 45          |
| <b>Chapter 6</b> | Care and maintenance                     | 53          |
| <b>Chapter 7</b> | Specifications                           | 55          |
| <b>Chapter 8</b> | Accessories                              | 59          |
| <b>Chapter 9</b> | Glossary                                 | 61          |

# Chapter 1

## Unpacking and preparing for operation

- 1.1 Checking Supplied Equipment
- 1.2 Basic Knowledge
- 1.3 Power Sources
- 1.4 Positioning Locator 2
- 1.5 Switching Locator 2 On and Off

---

### 1.1 Checking Supplied Equipment

Locator 2 is available with a wide range of accessories. Check that the contents of your shipment match all the items listed on the packing note. If any items are missing please contact your supplier immediately.

---

### 1.2 Basic Knowledge

As a general rule, effective use of eddy current equipment for new applications requires the following:

- An understanding of the principles of eddy current testing, particularly aspects which may limit detectability of defects such as depth of penetration and the way in which different probe configurations respond to defects.
- An understanding of other NDT and inspection techniques which may be more appropriate or which may be required to verify results.
- A knowledge of the application, i.e. the way in which the part being tested is manufactured or stressed in use and the probable defect mechanisms.
- Existing applications require a good working knowledge of the equipment to be used plus a written technique to be followed in performing the inspection.

---

### 1.3 Power Sources

Connect Locator 2 to power source. This will depend on the configuration of Locator 2 purchased and can be an advanced lithium-ion battery, AA cells or connection to an AC supply via the charger eliminator unit. For information on these options see Chapter 4, Power Sources and Battery Management.

---

### 1.4 Positioning Locator 2

Locator 2 is a versatile, lightweight unit that is designed for operation in a wide range of environments. A variety of accessories is available for setting the unit in the optimal position for operator ease including tripods and other camera accessories. These can be secured to Locator 2 using the camera thread provided on the lower edge (see Fig 1.1).

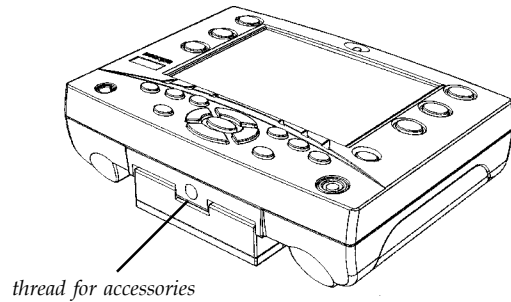

Fig 1.1 - Position of Tripod Mount

**Note...**

Locator 2 has designed to be rugged, splash resistant and also resistant to dirt and dust ingress. The unit is rated to IP64. However, it should not be considered drop proof or water proof, and care should be taken to position it to prevent damage due to falling or immersion in water.

Locator 2 has high grip rubber handles on the rear of the unit and these are intended to prevent sliding of the unit when placed on inclined shiny surfaces. Care should be taken to keep the rear of the Locator 2 clean to prevent scratching of the surface. Avoid placing the instrument on contaminated surfaces where it might pick up abrasive particles.

## 1.5 Switching Locator 2 on and off

Once a suitable power source has been connected to Locator 2 the unit can be switched on by a single press on 

The unit will then display the welcome screen momentarily, followed by the operating screen, (fig 2.2).

The unit can be switched off by pressing and holding  for more than 2 seconds.

**Note...**

A short press on  switches backlight on and off.

## Chapter 2

### Introduction to controls and basic setup

- 2.1 Introduction to Locator 2 controls
- 2.2 Changing between operating and menu screens
- 2.3 Changing Settings using Menus and Cursors
- 2.4 Setting the Time and Date
- 2.5 Switching the backlight on and off
- 2.6 Setting the Display Contrast level
- 2.7 Setting the Automatic Power Down function
- 2.8 Setting the Language
- 2.9 Selecting Key Click
- 2.10 Selecting the Graticule
- 2.11 Defining User Programmable Softkeys
- 2.12 Using Pre-Programmed Softkeys
- 2.13 Balance, Clear and Freeze buttons
- 2.14 Keyboard Lock

#### 2.1 Introduction to Locator 2 controls

All operating controls are available on the front panel of the instrument. The most frequently used controls (balance, clear and freeze) are located vertically beside the screen. These buttons are duplicated on either side to allow both left handed and right handed operation.

These keys have two functions. The short press function is as indicated by the light writing on the dark background (i.e. Balance, Clear, Freeze). The second functions are invoked by a long press and are as indicated by the dark writing on the light ellipse (i.e. Automatic Load selection, Clear Reference Trace and Keyboard Lock). These are positioned to be most accessible during operation (see 2.13 for further information).

All the controls required for adjustment of operating settings are based along the lower edge of the screen. Softkeys are engraved with F1 to F6 for ease of reference (see 2.11).

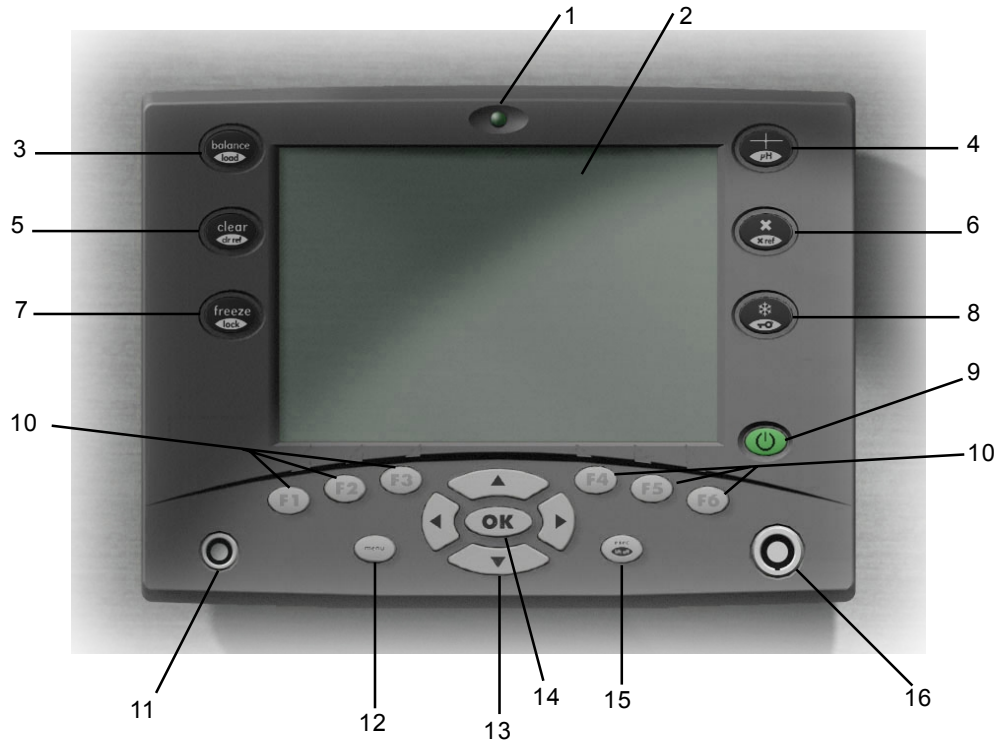

Figure 2.1 - Locator 2 front panel

- 1 Visual Alarm - Three colour light emitting diode (LED)
- 2 Display - Liquid Crystal Display (LCD)
- 3&4 Balance/Auto Load Select button\*
- 5&6 Clear/Clear Reference Trace button\*
- 7&8 Freeze/Keypad Lock button\*
- 9 Power/Backlight button
- 10 User-programmable Softkeys
- 11 Auxiliary socket
- 12 Menu button
- 13 Cursor button
- 14 OK button
- 15 Exec/Auto lift-off button\*
- 16 Probe socket

\*secondary functions are invoked by a long press

## 2.2 Changing between operating and menu screens

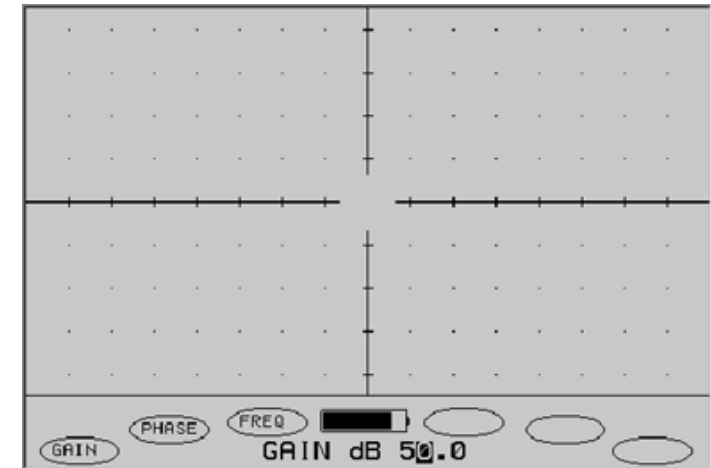

Figure 2.2 - Locator 2 operating screen

To change between the operating screen and the menu screen press the MENU button.





Figure 2.3 - Locator 2 menu screen

The menu screen shows all the settings available for Locator 2. For this reason some variables that are not necessarily being used (e.g. alarm settings) will still be visible in the menu view

### 2.3 Changing Settings using Menus and Cursors

To change settings on Locator 2 the following general guidelines apply. There are some special cases explained in the relevant sections.

Use  to switch to the menu screen.

Use  to move to the relevant setting.

Press  button to highlight the setting.

Use  to change the setting.

Press  to exit the setting mode.

*Note...*

Function of the cursor buttons may vary depending on the type of variable.

Alternatively the operator can switch back to the operating screen once the menu item has been highlighted by pressing the menu button. The variable will now be displayed on the operating screen. At this point it can be adjusted using the cursor buttons.

### 2.4 Setting the Operating Language

```
POWER DOWN  10 min
LANGUAGE     English
```

Locator 2 can be set to operate in a range of languages. Available languages are English, French, German, Spanish and Portuguese. Use the Up cursor button to move through the available languages. When the required language has been selected press OK to deselect the item. To refresh the entire menu screen in the new language press the menu button twice to re-write the new screen.

### 2.5 Setting the Time and Date

Setting the time and date will enable all stored traces and settings to have accurate date and time information stored with them.

Switch the unit on.

Press  to enter the menu screen.

Using  move to the third menu column.

Move to the item named Year.

Press  to highlight the setting.

Press  and  to select the correct year.

Once the year has been set press the  again to exit the setting mode.

Move up to MONTH and perform the same operation.

Continue the procedure as stated above for DAY, HOUR and MINS.



Once this has been completed press  to return to the operating screen.

### 2.6 Switching the backlight on and off

For operation in low light environments Locator 2 has an inbuilt LED backlight. The backlight has three settings - Off, Normal and High.

To step through the three settings press  until the required level of backlight is set.

Operating the unit with the backlight switched on will increase the battery power consumption. In conditions of high ambient lighting it may not be evident if the backlight is on or not. For this reason an icon is provided in the lower right hand area of the operating screen when the backlight is active.

 indicates high backlight level.  indicates normal backlight level.

### 2.7 Setting the Display Contrast level

```
CONTRAST    8
```

Locator 2 has a variable display contrast setting to allow the user to set the contrast to the optimum for the ambient lighting and temperature. Range is from 1 to 16.

Step to CONTRAST in the third column. To change the setting in steps of two use the Left and Right cursor buttons.

*Note...*

Changes in temperature may cause a change in the characteristics of the LCD display. In this case the contrast control should be used to compensate for this effect.

### 2.8 Setting the Automatic Power Down function

```
POWER DOWN  10 min
LANGUAGE     English
```

Locator 2 is provided with a selectable power down function. This switches off the unit after a predetermined period of inactivity. Settings are Off, 5, 10, 15 or 20 minutes. This function will preserve battery life in situations when the equipment is not in constant use.

*Note...*

When the unit closes down due to the Automatic Power Down function all settings will be preserved and will be restored when the unit is switched back on.

## 2.9 Selecting the Graticule

```
LOAD uH      8.2 |
GRATICULE    Rect A |
SPOT X       0 |
```

A suitable graticule for the inspection can be selected from a choice of four different types; NONE, RECT A, RECT B and POLAR.

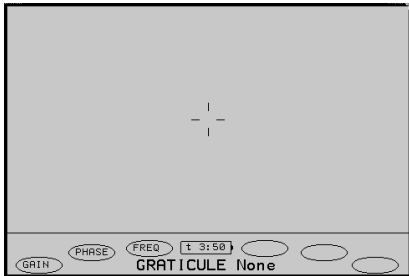

Graticule - NONE

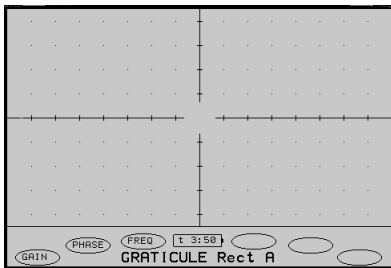

Graticule - Rect A

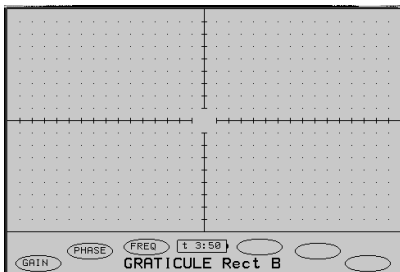

Graticule - Rect B

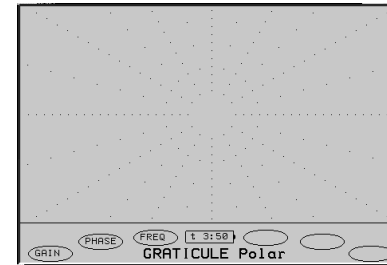

Graticule - Polar

## 2.10 Selecting Key Click

```
KEY CLICK    Off |
```

Audio feedback from the unit can be selected so that even when operating the unit in heavy gloves an operator will be able to determine whether a key press has been successful. Set to ON or OFF.

## 2.11 Defining User Programmable Softkeys

Each of the six softkeys on the front panel of Locator 2 can be allocated to any setting as required by the operator (Item 10, Fig 2.1).

Press **menu** to enter the menu screen. Use the cursor buttons to step to the required setting.

When it is highlighted press and hold one of **F1**, **F2**, **F3**, **F4**, **F5**, **F6**

After 2 seconds the setting will appear in the corresponding on-screen softkey location.

*Note...*

The variable must be selected by **OK** in order to be programmed to a softkey.

Press **menu** to return to the operating screen.

Pressing a softkey will bring up the associated variable for adjustment by the cursor buttons.

To clear a softkey press and hold the softkey for two seconds whilst on the operating screen.

## 2.12 Using Pre-Programmed Softkeys

For three frequently used operations, Spot position, Box Gate Alarm, and Sector Alarm there is easy access to these settings via the pre-programmed softkeys.

To invoke these press **OK** whilst on the operating screen. An icon on the right hand side of the display indicates which softkey mode the instrument is in.



X and Y position Softkeys



Box Gate alarm Softkeys



Sector alarm Softkeys

Another press on **OK** will revert to user programmed softkeys and the icon will disappear.

## 2.13 Balance, Clear and Freeze Buttons

These buttons are located on either side of the display to allow both right and left handed operation..



Balance button.

This balances the unit and returns the working point to the origin. This point can be moved (see 3.15). A long press invokes automatic load selection (see 3.4).



Clear button.

This clears any traces that have been either frozen on screen or that remain if the persistence has been set to permanent (see 3.15). A long press will remove any recalled traces that are being used as reference traces (see 3.23).





Freeze button.

This button will freeze a trace on screen. This is required before storing a trace (see 3.23), and is useful for keeping a trace on screen for evaluation if the persistence is not set to permanent. A long press will initiate the Keyboard Lock (see 2.14)



## 2.14 Keyboard Lock

To prevent accidental key presses changing the settings, the keyboard can be locked. This prevents the operation of all menu keys.

Balance, Clear and Freeze buttons (see 2.13) will continue to remain active when the keyboard is locked.

The keyboard lock is invoked by a long press on  / 

A key icon appears on the display to indicate that the keyboard lock is active.

The keyboard lock is removed by a long press on  / 

## Chapter 3

### Operation of Locator 2

- 3.1 Connecting a Probe
- 3.2 Selecting Probe Type
- 3.3 Frequency
- 3.4 Selecting a balance load - Absolute and Locator probes
- 3.5 Balancing the probe - all types
- 3.6 Automatic Lift-Off Compensation
- 3.7 Gain
- 3.8 Signal Phase
- 3.9 X:Y Ratio
- 3.10 Overview of Filters
- 3.11 High Pass Filters
- 3.12 Low Pass Filters
- 3.13 Display
- 3.14 Sweep
- 3.15 Persistence
- 3.16 Spot Position
- 3.17 An Overview of Alarms
- 3.18 Box Gate Alarms
- 3.19 Sector Alarms
- 3.20 Alarm Tone
- 3.21 Alarm Stretch
- 3.22 Alarm Volume
- 3.23 Saving Traces and Setups
- 3.24 Recalling Traces and Setups
- 3.25 Allocating Trace and Setup permissions
- 3.26 Record replay feature

*Note...*

For the following instructions it is assumed that the operator is familiar with the method of changing variables described in 2.3 - Changing Settings using Menus and Cursors

### 3.1 Connecting a Probe

A very wide range of eddy current probes may be used with Locator 2. They may be connected directly by an appropriate cable or via adapters in the case of probes made for other instruments. The primary probe connector on Locator 2 is the 7 way Lemo connector on the right hand side of the front panel (item 11, Fig 2.1).

For Absolute probes terminated in a Microtech connector a Lemo 7 way to Microtech lead is available (Hocking PRN 39A001).

For existing absolute probe cables terminated in a BNC cable a Lemo 7 way to BNC adapter is available (PRN 39A003). For other probes, please see Chapter 8, Accessories.

### 3.2 Selecting Probe Type

Probe type will depend on the inspection, taking into consideration the flaws that are being inspected for. Flaw geometry, as well as material type and depth of penetration required will result in a probe specification. Once this probe has been selected Locator 2 can be set to match the connected probe type.

It is important to understand that probes are configured as a choice of EACH of the following elements:

- Absolute or Differential
- Bridge or Reflection
- Shielded or Unshielded

With some eddy current instruments the probe must be hardwired into the configuration required. However with Locator 2, the operator can drive some probes in a variety of ways. For this reason it is possible to drive some probes in different ways e.g. a differential probe as an absolute probe.

This flexibility allows for a range of configurations with a single probe, however care must be taken to ensure that the effects of this configuration are understood by the operator.

```
PROBE  Locator
```

```
PROBE  Absolute
```

```
PROBE  Reflection
```

```
PROBE  Bridge
```

Probe type can be set to Locator, Absolute, Differential (Bridge) or Reflection.

Locator mode is a dedicated mode that is designed to match the impedance of all absolute Locator probes at 100 Ohms.

The Absolute mode is for Absolute probes with an impedance of 50 Ohms.

For Absolute or differential probes intended for bridge operation the setting should be Bridge.



For driver/pick-up probes the Reflection setting probe should be used.

### 3.3 Frequency

```
GAIN dB      40.0
PHASE °      180.0
FREQUENCY    10 KHz
```

Locator 2 has a range of fixed frequencies selectable between 100Hz to 6MHz. Select FREQUENCY from the menu.

Set frequency appropriate to test and probe.

 and  give large steps through the frequencies as follows:

100Hz, 1kHz, 10kHz, 100kHz, 1MHz, 6MHz.

 and  give fine steps as follows:

Hertz : 100, 120, 150, 200, 250 300, 400, 500, 600, 800



kHz : 1, 1.2, 1.5, 2, 2.5, 3, 4, 5, 6, 8, 10, 12,15, 20, 25, 30, 40, 50,  
60, 80, 100, 120, 150, 200, 250, 300, 400, 500, 600, 800

MHz : 1, 1.2, 1.5, 2, 3, 4, 6

Correct frequency selection is critical for a good inspection and is dependent on the probe being used and the depth of inspection required.

### 3.4 Selecting a balance load - Absolute and Locator probes

Locator 2 has a series of internal balance loads to balance Absolute and Locator probes. Attach a suitable probe and go to the operating screen (Fig 2.2).

Press and hold the  /  for approximately 2 seconds, until the auto load detect process starts.

Locator 2 will select a suitable load in order to balance the absolute probe. If the operator wishes to override the selection then this can be performed by going to the Load item on the menu screen.

```
INPUT GAIN      Low
LOAD uH         8.2
GRATICULE      Rect A
SPOT X          0
SPOT Y          0
```

### 3.5 Balancing the probe - all probe types

For all types of probes the probe should be placed on a known good section of material and the balance button pressed. If the probe cannot be balanced the message BALANCE FAILED will be displayed. A failed balance may be for a variety of reasons:

- Incorrect probe selection (see 3.2)
- Incorrect frequency selection (see 3.3)

- Probe drive saturated, i.e. Gain too high (see 3.7)
- Incorrect Load selection for absolute probe (see 3.4)
- Probe worn or damaged, or lead damaged (check equipment)

### 3.6 Automatic Lift-Off Compensation

An automatic facility is provided to correctly position the lift-off signal.

To perform this procedure place the probe on known good metal of the type to be inspected.

Press and hold  for 2 seconds.



The unit will balance. When the unit displays LIFT PROBE the probe should be removed from the surface of the metal. The unit will automatically rotate the phase of the signal so it is in the correct orientation.



If the LIFT PROBE message shows for more than 2 seconds after you have lifted the probe then automatic lift-off compensation has failed. If this occurs, please see reasons for balance failure in section 3.5. Also, the gain may need to be increased so that the lift-off signal is greater than one half screen height.

### 3.7 Gain



Select GAIN from the menu and press  so that one numeral of the variable is highlighted.

This number can be varied by  and .

Step to the next character using  or .

This system allows both large changes in gain or fine tuning of the gain.

The sensitivity of the probe can be increased by switching the Input Gain from Low (+0dB). to High (+20dB). This increases the voltage at the probe, but for some probe types and materials this may cause problems with balancing (see 3.5).

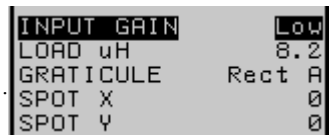

### 3.8 Signal Phase



Select PHASE from the menu.

The method for adjustment is the same as for Gain (see 3.7).



This feature allows rotation of the signal so that flaw indications can be presented in the clearest possible fashion, and is useful for ensuring that non flaw signals do not trigger alarms.

Phase is adjustable from 0 to 359.9 degrees in steps of 0.1, 1, 10 or 100 degrees as required.

### 3.9 X:Y Ratio



The X:Y ratio allows the operator to vary the relative gain between the X and Y axes. Select X:Y RATIO from the menu.

 and  give large steps through the ratios as follows:

16:1, 4:1, 1:1, 1:4, 1:16

 and  give fine steps as follows:

16:1, 8:1, 4:1, 2:1, 1:1, 1:2, 1:4, 1:8, 1:16

### 3.10 Overview of Filters

Filters are used to reduce or eliminate unwanted signals. High pass filters reduce low frequency components of signals and Low pass filters reduce high frequency components. These two type of filters can be used together to create a bandpass filter, and for this reason the frequency of the two sets of filters cannot overlap or the inspection bandwidth will be reduced to zero (i.e. no signal).

### 3.11 High Pass Filters



The High Pass filter reduces low frequency components such as product vibration, geometry and temperature drift changes. If the probe does not traverse a crack quickly the unit may treat it as a slowly varying signal and the indication will be reduced.

High pass filters can be used effectively during hand scanning where there are slowly

changing effects but care should be exercised to move the probe at a constant speed. Settings greater than 10Hz may be unsuitable for hand scanning. For tests with a rotating component higher settings may be appropriate.

Select HIPASS from the Menu.

Use  to change the value.

The DC setting indicates that no low frequency signals are being filtered.

```
HIPASS      U0.02Hz
LOPASS      300 Hz
```

ULTRA is a filter setting that removes the effect of very long timebase signals, and will reduce or remove the effect of long term drift of the balance point. This has a range of timebases that it averages over so that different scanning speeds etc. can be compensated.

Ultra filters are indicated by a U prefix before the value.  
 U0.01Hz, U0.02Hz, U0.05Hz, U0.1Hz, U0.2Hz, U0.5Hz

Standard DC filter settings available are (in Hz):  
 1, 2, 5, 10, 20, 50, 100, 200, 500.

*Note...*  
 Low Pass filter settings will affect whether a High Pass filter can be selected or not.

### 3.12 Low Pass Filters

```
HIPASS      Ultra
LOPASS      30 Hz
```

The Low Pass filter reduces and eliminates rapid signal changes such as electrical noise. If a defect is traversed quickly with a probe, a low pass filter unit will treat it as a rapidly changing signal and the indication will be reduced. The filter setting is sometimes a compromise between acceptable noise and ability to respond to fast flaw signals.

Select LOPASS from the Menu.

Use  to change the value.

Settings available are (in Hz):  
 1000, 750, 500, 300, 200, 100, 75, 50, 30, 20, 10, 5, 3.

### 3.13 Display

```
DISPLAY      Spot
SWEEP        1.0 secs
PERSIST      1.0 sec
```

Display type can be selected between SPOT and TIMEBASE.  
 SPOT mode (or XY display) is the display mode used for the majority of applications.

This displays both the X and Y components of the impedance plane.

TIMEBASE mode (or YT display) is the mode in which the Y component is represented against time. In this mode some of the menu items are not valid, such as X:Y ratio, Graticule, and Sector Alarm. However these items are still displayed and can be modified. The T component (time) can be changed by changing the SWEEP variable below.

### 3.14 Sweep

```
DISPLAY      Spot
SWEEP        1.0 secs
PERSIST      1.0 sec
```

Sweep applies only when TIMEBASE has been selected. This varies the time that it takes the spot to cover one major division on screen.

Settings available are (in seconds):  
 0.1, 0.2, 0.5, 1, 2, 5, 10, 20, 50.

### 3.15 Persistence

```
DISPLAY      Spot
SWEEP        1.0 secs
PERSIST      1.0 sec
```

This function sets the time for which data is retained on the display before it is refreshed. When set to permanent the data on the screen remains until the Clear button is pressed.

Settings available are (in seconds):  
 0.1, 0.2, 0.5, 1, 2, 5, 10 and permanent.

### 3.16 Spot Position

```
GRATICULE    Rect A
SPOT X       0
SPOT Y       0
```

The position of the spot can be adjusted to define the origin. This only applies when DISPLAY is set to SPOT. When the spot position is altered the graticules move automatically to indicate the origin point on screen. If the graticule is set to NONE there are cross hairs to indicate the origin as shown below

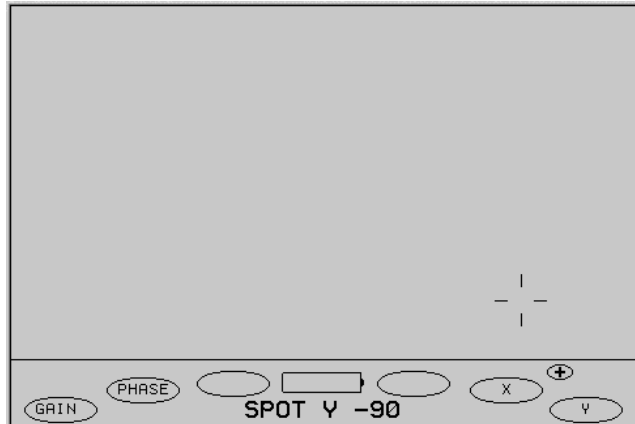

The cross-hairs allow the operator to observe if the balance point has drifted or moved due to an artefact or material condition.

The spot position can be moved from -240 to +240 in the X axis and -135 to +135 in the Y axis.

◀ and ▶ give large steps of 30 pixels.

▲ and ▼ give fine steps of 1 pixel.

To move spot position whilst on the operating screen use the Spot Position Pre-Programmed Softkeys (see 3.10).

### 3.17 An Overview of Alarms

|             |         |
|-------------|---------|
| ALARM SHAPE | Off     |
| TOP         | Off     |
| BOTTOM      | Off     |
| LEFT        | Off     |
| RIGHT       | Off     |
| START ANGLE | 10      |
| END ANGLE   | 120     |
| INNER       | 30      |
| OUTER       | Off     |
| ALARM TONE  | Off     |
| STRETCH     | 50 msec |
| VOLUME      | 5       |

The Alarm menu field shows the complete alarm configuration at a single glance. There are two types of alarm; BOX and SECTOR. An alarm condition can be indicated in a number of ways, including visual alarm via the LED (Item 1, Fig 2.1) and an alarm tone.

| Condition               | LED    | Alarm Tone                       |
|-------------------------|--------|----------------------------------|
| Spot enters alarm area  | Red    | Sounds if selected               |
| Spot leaves alarm area  | Orange | Sounds for ALARM STRETCH period. |
| Spot outside alarm area | Green  | Silent                           |

To improve audibility, the Alarm may be stretched to lengthen the audible alert.

**Note...**

Only one type of alarm can be active at a time, and if ALARM SHAPE is set to off no alarms will appear, even if settings appear on the menu screen.

An alarm can be switched off by setting ALARM SHAPE to OFF.

### 3.18 Box Gate Alarms

BOX alarm can be selected as a threshold (X or Y) or as a complete box.

To set a BOX go to ALARM SHAPE and select BOX.

1. Press **menu** to return to the operating screen
2. Press **OK** until the BOX Pre-Programmed Softkeys appear ( ) (see 3.10)
3. Press Softkey F3 to call up the TOP dialogue.
4. Press **exec lift off** to activate the box alarm TOP function.

Now a threshold alarm will appear:

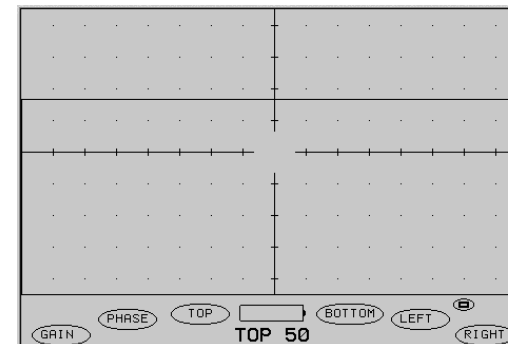

Box alarm with only Top selected

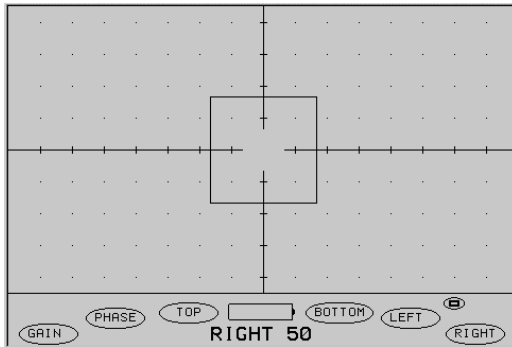

Box alarm centred on balance point

To get a full box the BOTTOM, LEFT and RIGHT functions must be switched on. Select the relevant softkey and press  to create a BOX (see above). If the BOX centred on the balance point then an alarm condition will be created when the working point goes outside the BOX. If a BOX is not centred on the balance point then the alarm will indicate when the working point goes inside the BOX (see below).

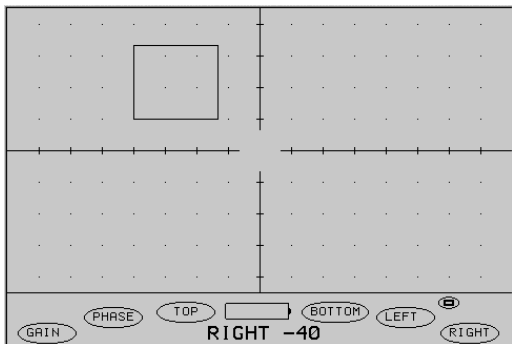

Alarm not centred on balance point

### 3.19 Sector Alarms

The sector alarm has the same versatility as the BOX alarm, and works on a similar principle.

1. To set a Sector Alarm go to Alarm Shape on the Menu and select SECTOR.
2. Press Menu to return to the operating screen.
3. Press OK until the Sector Pre-Programmed Softkeys appear (  ).
4. Press Softkey F3 to select the START setting.
5. Adjust the start point of the sector by using the cursor buttons. The Left and Right cursor buttons will move the threshold in steps of 10. The Up and Down cursor buttons move the threshold in steps of 1.

6. Press Softkey F4 to select the END setting. Adjust the end point of the sector by using the cursor buttons. The Left and Right cursor buttons will move the threshold in steps of 10. The Up and Down cursor buttons move the threshold in steps of 1.

**Note...**

The sector alarm will wrap to a full circle if the start point is set higher than the end point or if the end point is set lower than the start point. The controls will continue to work as described above.

7. Press Softkey F5 to select the INNER setting. Adjust the position of the inner of the sector by using the cursor buttons. The Left and Right cursor buttons will move the threshold in steps of 10. The Up and Down cursor buttons move the threshold in steps of 1.
8. Press Softkey F6 to select the OUTER setting. If the outer setting is not switched on the alarm will appear as below.
9. Press the Exec button to switch the OUTER setting on. Adjust the position of the outer of the sector by using the cursor buttons. The Left and Right cursor buttons will move the threshold in steps of 10. The Up and Down cursor buttons move the threshold in steps of one. A sector Alarm with the OUTER switched on is illustrated above.
10. Press Softkey F3 to select the START setting.

**Note...**

In the case of Sector Alarms  only needs to be pressed to activate OUTER.

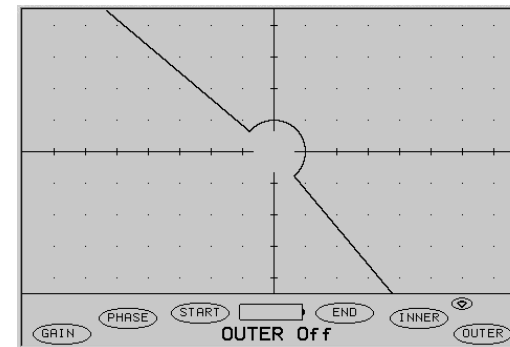

Sector Alarm with Outer switched off

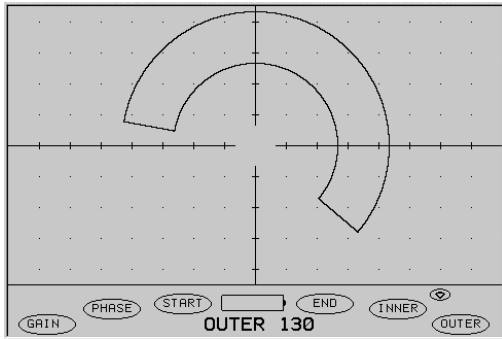

Sector Alarm with Outer switched on

### 3.20 Alarm Tone

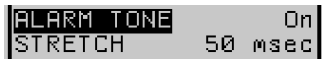

This setting controls the audible alarm. The audible alarm is triggered when an alarm condition is met, and will continue to sound whilst the working point is in the alarm area. Once the working point has left the alarm area the alarm will sound for as long as is defined by the Alarm Stretch function (see 3.21).

### 3.21 Alarm STRETCH

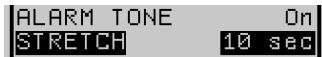

This setting allows the alarm to be stretched for 50msecs, 100msecs, 500msecs, 1 second, 5 seconds and 10 seconds. This function is relevant where a short alarm might be missed but it is important to note that several flaws close together will not be resolved if the alarm stretch is too long (see below)

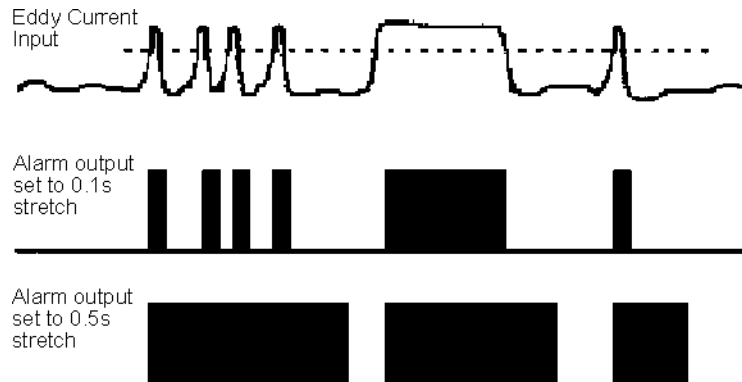

### 3.22 Alarm Volume

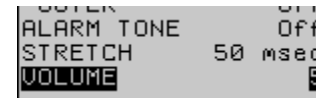

Volume applies to the output level to the optional earpiece (Hocking PRN 39A025). Connect the earpiece to the auxiliary socket. Adjust the volume so that the output level is acceptable and can be heard above background noise.

**WARNING**

AS WITH ANY AUDIO DEVICE CARE SHOULD BE TAKEN TO AVOID EXPOSURE TO EXCESSIVE VOLUME LEVELS, WHICH MAY CAUSE DAMAGE TO HEARING.

### 3.23 Saving Traces and Setups



To save a trace first create the trace on screen.

Press / to freeze the display.

Go to SAVE and select TRACE.

Press to enter the Save screen below.

### 3.24 Recalling Traces and Setups



The instrument will move to the next available storage space.

**Note...**

If a trace or setting has been saved then Locator 2 will automatically duplicate the previous saved item and add an incremental character to help the operator name subsequent traces rapidly. If the automatic name is not required it can be immediately cleared with a single press of the F2/Clear softkey.

Once in the SAVE screen the Softkeys below appear.



To move to a new storage space press F5 and F6 to move up and down the list.



Using the directional pad, the operator can name the file using the alphanumeric box

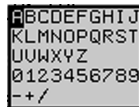

Press **OK** to accept each letter.

Any mistakes in the file name can be corrected by moving the cursor to the correct point by using F3 and F4. Once the file has been named press SAVE/F1 to exit the field. To escape without saving

any changes, press **exec** (lift off).

To save setups do the same as above but ensure SAVE is set to SETUP.



To recall a trace move to RECALL and select TRACE. Press **exec** (lift off) to enter the Recall screen.

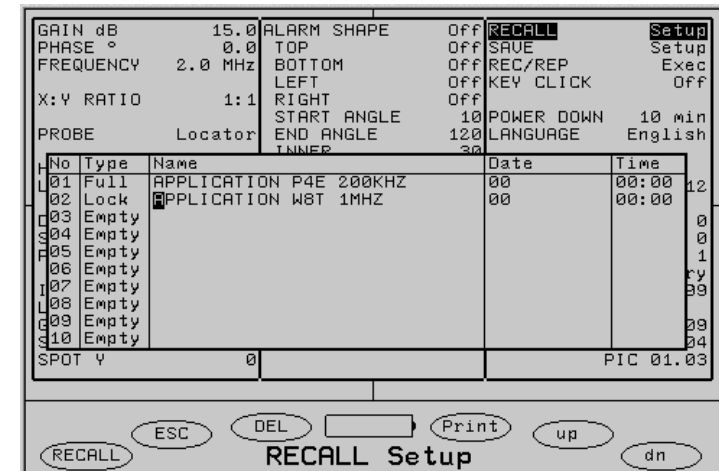

To move to the location use F6/DN to move down and F5/UP to move up.



To leave the dialogue without recalling press F2/ESC.

To clear the location without leaving the dialogue press F3/DEL.

To recall the trace press RECALL/F1.

To exit, press 

To recall a SETUP do the same as above but ensure RECALL is set to SETUP.

To clear the reference trace from the screen press and hold  / 

### 3.25 Allocating Trace and Setup permissions

The Trace and Setup Files have four different Type statuses; Empty, Full, Lock and User. To access these settings, select RECALL, Setup/Trace and press 

The status can be read from the Type column on the Recall screen (the second column).

| No | Type  | Name      |
|----|-------|-----------|
| 01 | Full  | WELDSCAN  |
| 02 | Lock  | WELDSCAN2 |
| 03 | User  | WELDSCAN3 |
| 04 | Empty |           |
| 05 | Empty |           |
| 06 | Empty |           |

'Empty' indicates that no data has been stored in the location.

'Full' indicates that data has been stored in the location. This is the default data Type.

'Lock' prevents the user from accidentally deleting the file when recalling the data.

'User' enables an operator to recall the Trace or Setup when in User mode. (See 5.10). When in User mode no other Traces or Setups can be recalled.

To Change the data type go to the required data location via the recall screen (see 3.24). Press the OK button. The data Type will change to User. A further press will change to Lock.

To return the Type to Full, select RECALL from the menu screen, and select LOCK if necessary. Press the FREEZE button.

Press  to return to the menu.

### 3.26 Record replay

Locator 2 has the ability to record and replay signals for post-processing. This facility allows the operator to scan a test piece or suspect area and subsequently optimise the display. The recording period is approximately 15 seconds.

To initialise the record replay mode, press menu and move the cursor to the third column to highlight REC/REP.

Press the Exec button. The display will now change to the operating screen with record/replay softkeys.

To commence the trace recording press F6/Record.



Once the recording has been initiated a cursor will move across the bottom of the recording screen. After approximately 15 seconds the buffer will be full. At this point the display will appear as below.

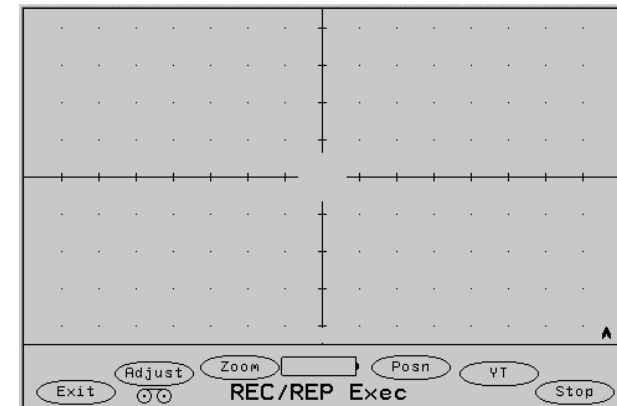

Press F6/Stop in order to save the recording for post-processing. To erase the recording press F1/Exit in order to return to the standard operating screen.

At this point the recorded trace can be manipulated to play back the section of signal. Press F4/Posn to move the recording cursor with the cursor keys to the section of playback to be replayed.

The  symbol indicates that data currently being displayed has been recorded.

Press F3 Zoom to crop the signal to the area of interest, using the cursor keys to adjust the level of zoom.

F2/ Adjust allows you to adjust operation settings, e.g. gain, phase, X:Y ratio etc.

To return to rec/replay operating screen, select REC/REPLAY in the menu, press  and



To toggle the signal between YT and XY playback mode press F5/YT/XY once.

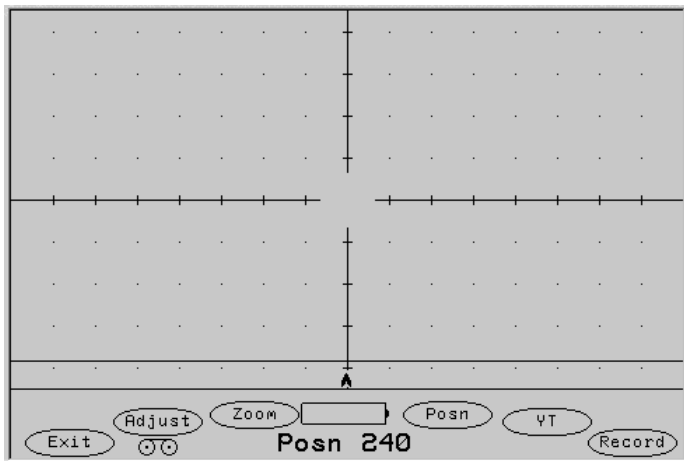

To return to the normal Operating Screen press F1/Exit.

## Chapter 4

### Power sources and battery management

- 4.1 Removing and installing the Battery Pack
- 4.2 Battery charger/eliminator
- 4.3 Lithium-ion battery pack
- 4.4 Battery charge indicator (Lithium-ion only)
- 4.5 AA battery/eliminator pack
- 4.6 Placing cells in the AA battery/eliminator pack
- 4.7 Restarting after unexpected power down

---

#### 4.1 Removing and installing the battery pack

Locator 2 has a variety of power options. The various choices all use the same method of connecting to the unit as outlined below:

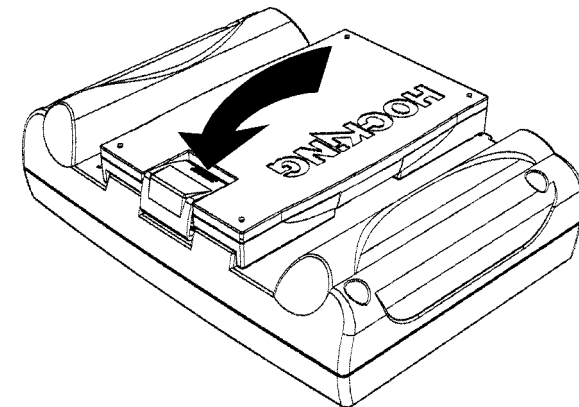

Place the Locator face down on a soft, clean surface.  
Press down on the battery release clip as indicated above.  
Roll the battery pack away from the unit.  
Installation is the reverse process.

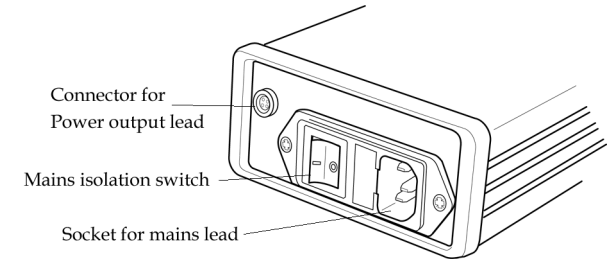
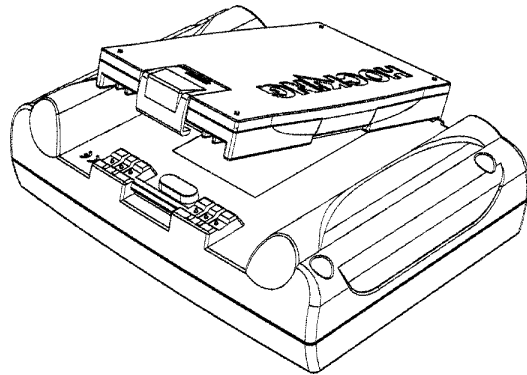

The charger has automatic safety protection to ensure that it will only charge the Lithium-ion battery pack supplied for Locator 2, and will not charge the AA/eliminator pack if it is placed on the unit.

**Note...**

The charger/eliminator unit will continue to supply to Locator 2 even when recharging a lithium-ion battery.

To charge the Lithium-ion battery pack place the battery on top of the unit in exactly the same way as described in 4.1.

Different conditions of the battery charger and Lithium-ion battery pack are indicated in the table below.

**4.2 Battery charger/eliminator**

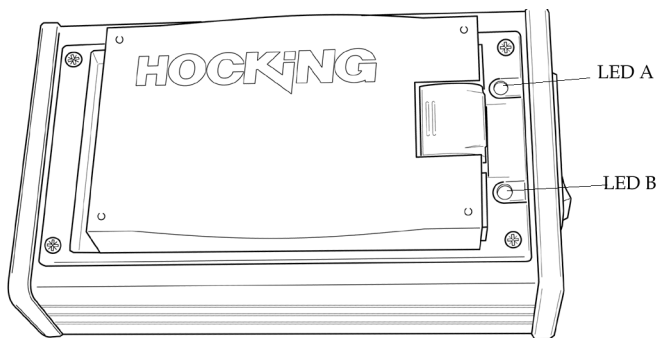

The battery charger/eliminator should be connected an AC supply using an appropriately terminated plug. The adapter is able to switch to power supplies that are in the range of 90 to 264VAC, and 47 to 440Hz. Once the unit has been connected the mains switch on the side of the unit should be switched on.

| Condition                                  | LED A           | LED B               |
|--|-----------------|---------------------|
| Temperature OK                             | Solid Green     |                     |
| Temperature too high to charge             | Solid Red       |                     |
| Temperature too low to charge              | Solid Orange    |                     |
| Incorrect Battery Type                     |                 | Flashing Red        |
| Battery charging                           |                 | Flashing Green      |
| Battery charged                            |                 | Solid Green         |
| Battery not full after 3 hours             |                 | Solid Red           |
| Pre-Charge failed                          |                 | Solid Orange        |
| Battery not detected                       |                 | No light            |
| Unknown battery, pre-charging for 1 minute |                 | Flashing Red/Orange |
| Problem with power supply                  | Flashing Orange | Flashing Orange     |

The charger/eliminator pack has two modes of operation, Pre-charge and fast charge. The unit interrogates Lithium-ion packs when they are placed on the unit. If the unit has discharged to a very low level then the unit initiates a pre-charge routine that trickle charges the pack until it is ready to accept the fast charge. In the case of extremely discharged packs this process can take up to 90 minutes.

For packs in normal use the pre-charge is not necessary and the unit can start on a fast charge routine immediately.

Using the fast charge the pack can be supplied with enough charge in 30 minutes to provide over 6 hours of operation

#### CAUTIONS...

- (1) AS THE UNIT USES HIGH CURRENTS WHEN IN FAST CHARGE MODE THE UNIT WILL GET WARM. IT IS IMPORTANT THAT THE COOLING SLOTS IN THE SIDE OF THE BATTERY CHARGER/ELIMINATOR UNIT ARE KEPT CLEAR FROM OBSTRUCTION.
- (2) ENSURE THAT THE UNIT IS NOT EXPOSED TO DIRT OR FLUID AS THIS MAY DAMAGE THE UNIT.
- (3) HIGH VOLTAGES ARE PRESENT INSIDE THE UNIT. AS WITH ALL POWER SUPPLIES CARE MUST BE TAKEN IN HANDLING AND THE UNITS MUST NEVER BE OPENED BY NON-AUTHORISED PERSONNEL.

### 4.3 Lithium-ion battery pack

A Lithium-ion battery pack is available for Locator 2. This slimline package provides sufficient running power for over 14 hours of operation from a single charge (without backlight). The fully enclosed design means that there are no user serviceable parts. Lithium-ion batteries offer the highest possible energy density for the minimum size and weight. The fully charged cells provide sufficient energy for 14 hours continuous use without the backlight or 8 hours with backlight to Normal.

A significant advantage of this technology over other secondary battery technologies is that unlike NiCad or NiMH cells there is no requirement for cycling or deep discharging the batteries. Lithium-ion does not suffer from memory effects, therefore it is possible to top up batteries as required without losing battery capacity.

This battery technology has several levels of protection to ensure safety for the operator and equipment. However as with all forms of battery power care must be taken in handling these units.

#### Note...

The contacts are contained in a moulded feature on the pack providing barriers between the contacts and reducing the likelihood of inadvertent short circuit. Nevertheless the batteries should be handled with care, shorting the contacts may cause the cell protection to operate and render the pack useless. If it is suspected that the battery contacts have been shorted then the pack must be returned to a battery charger/eliminator unit. Placing the pack on the unit will allow the intelligent management system to establish whether the pack is useable or not.

The battery charge indicator on the screen will only work with the Lithium ion pack. If the AA/eliminator pack is attached then the battery charge indicator will not display a remaining charge indicator.

Charging of the Lithium-ion battery pack should only be performed using the Locator 2 battery charger eliminator.

### 4.4 Battery charge indicator (Lithium-ion only)

Locator 2 indicates the battery charge of Lithium-ion packs when they are operated on the unit. The indication of time remaining will alter with change in ambient temperature, use of backlight and inspection frequency, amongst others. This indication will not work with the AA pack. The unit will give a visual indication when there is 20 minutes to go by displaying a countdown in the battery graphic. If the unit is switched off during this countdown period the operator will need to recharge the battery before being able to switch the unit back on.

### 4.5 AA battery/eliminator pack

The AA battery /eliminator pack has two functions.

It is able to take standard dry cell AA batteries when required. The operator can use rechargeable technology AA cells such as NiCad or NiMH and recharge on a proprietary frame.

It connects the charger/eliminator unit to the Locator 2 by the Power Output lead (PRN 39A023) as illustrated below.

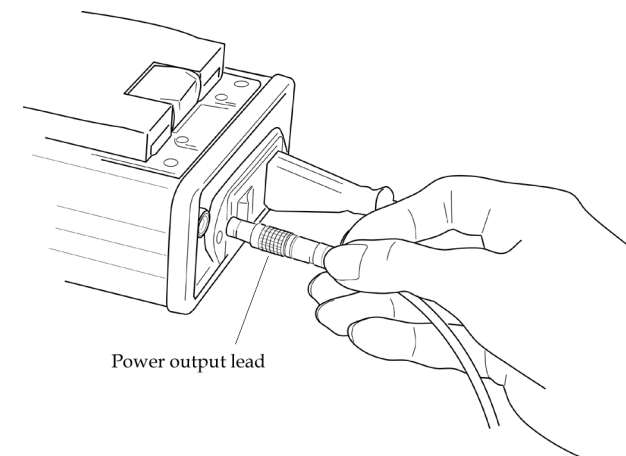
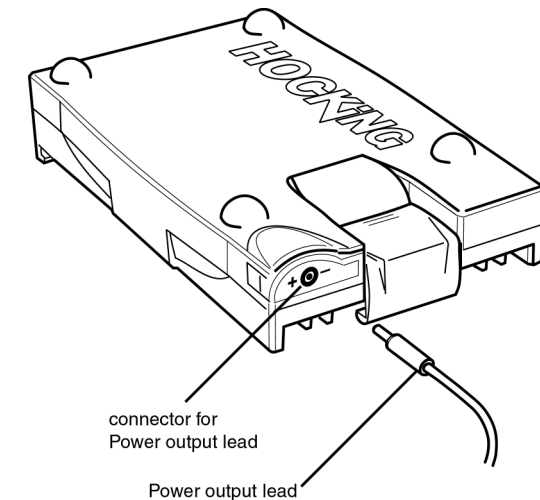

---

## 4.6 Placing cells in the AA battery/eliminator pack

Remove the AA battery eliminator pack from Locator 2.

Remove the pack cover by gently pulling the tabs located at the middle of the pack on either side.

Place 8 AA cells in the polarity indicated by the pack.

Replace cover by snap-fitting over the base.



### CAUTION

DO NOT USE A MIXTURE OF RECHARGEABLE AND ALKALINE CELLS. DO NOT USE CELLS THAT HAVE DIFFERENT AMP HOUR RATINGS. DO NOT MIX CELLS OF DIFFERENT CHARGE LEVELS.

---

## 4.7 Restarting after unexpected power down

If the power is removed without using the on/off switch there is a risk of memory corruption. Instances where this power down might occur are removal of the battery from the rear of the unit, whilst the unit is switched on, and removal of power from the AA battery/eliminator pack.

### NOTE...

When the power has been removed in such a manner the last operating screen will remain displayed and will gradually fade. Horizontal black bars may also be evident. This indicates an unexpected power loss.

Following such an instance the unit will display restore options when the unit is switched on again. The options are as below:

|             |   |    |
|-------------|---|----|
| TOTAL RESET | - | F1 |
| DEFAULT     | - | F6 |
| CONTINUE    | - | F3 |

TOTAL RESET clears all stored locations and sets the unit to factory defaults.

DEFAULT maintains stored locations and sets the unit to factory defaults.

CONTINUE maintains stored locations and unit settings.

It is advised at this point that the operator continues by pressing F3 to continue. This will start the unit in a normal manner without resetting any of the variables in the unit. However the user must check both the settings menu, and the stored traces and settings to check for evidence of corruption which would invalidate further operations. This will be evident by file locations reported as full that have no apparent data, and corrupted data labels etc.

If data corruption is evident then the unit should be switched off.

When the unit is switched back on the operator should press and hold the F5 button.

This will bring up the reset menu, and depending on the perceived level of corruption either TOTAL RESET or DEFAULT should be implemented.

## Chapter 5

### SupervisorPC Lite (option)

- 5.1 System requirements
- 5.2 Software installation
- 5.3 Connecting to Locator 2
- 5.4 Starting SupervisorPC Lite
- 5.5 Downloading traces and settings
- 5.6 Quick printing
- 5.7 Creating a report
- 5.8 Saving and printing a report
- 5.9 Changing the default editor and template
- 5.10 Restricting Locator 2 Operation
- 5.11 Remote control of Locator 2
- 5.12 Using Locator 2 Help

---

#### 5.1 System requirements

It is assumed that the operator is familiar with the operation of a PC and working in the Windows environment. SupervisorPC Lite requires a PC computer running on either Windows 95 or Windows 98 Operating system. Minimum specifications for the PC are:

- 90MHz Pentium processor
- 16MB Ram
- 100MB Hard disk
- CD-ROM drive
- Serial communication port with 9 way D-type connector

---

#### 5.2 Software installation

Switch on the PC.

Close any applications that are running to minimise the chance of installation conflicts.

Insert the Supervisor PC Lite CD in the CD-ROM drive. The software installation should start running automatically.

However, if this should fail, open the root directory for the CD and open the folder called INSTALLATION. Double click on the application entitled SETUP.EXE, and follow the on-screen instructions.

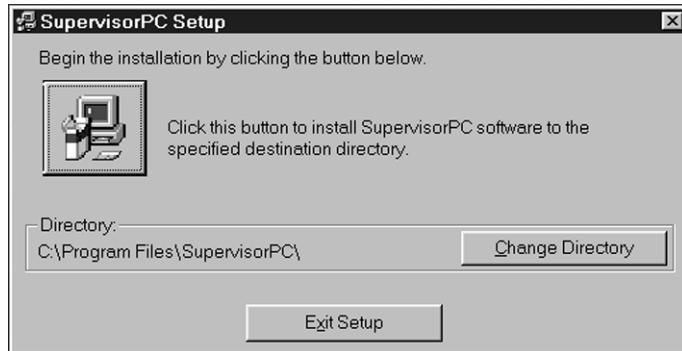

Fig 5.1 setup screen

Click on the Computer icon to continue installation.

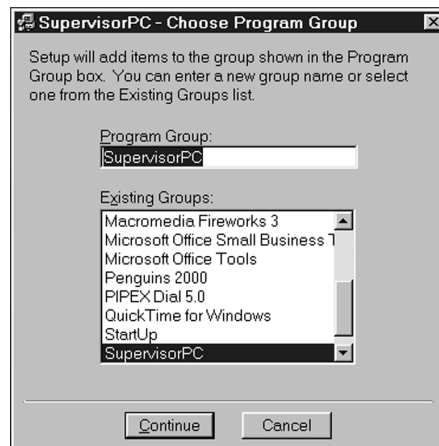

Fig 5.2 Program group configuration

When the program group configuration dialogue appears (Fig 5.2) type the required name in the highlighted box and press continue to complete the install.

Remove the CD and store safely for future reference.

If any problems should occur during installation or operation, please read the "readme.txt" file in the root directory of the CD.

### 5.3 Starting Supervisor PC Lite

Go to the Supervisor PC program group and select the Supervisor PC program. The main screen will appear.

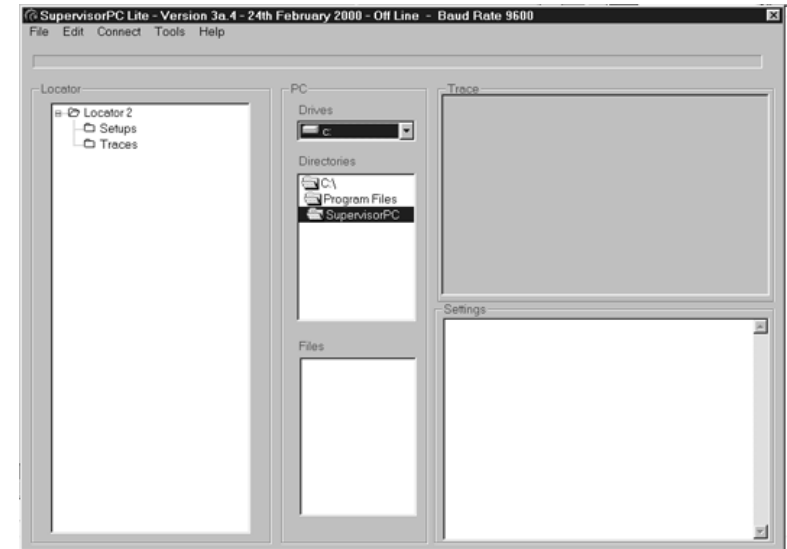

Inspecting the File, Edit, Connect, Tools and Help menu will reveal that certain options are greyed out. These options are dependant on whether the software is connected to an operational Locator 2.

When connected to Locator 2 (see 5.4) these options will become available. However the simulation in the Tools menu is only available when the software is not connected.

### 5.4 Connecting Locator 2

Connect the RS232 communications cable (part no.39A024) to the COM1 port of the PC. Insert the Lemo 5 way connector of the RS232 lead into the auxiliary socket of Locator 2. Switch on the Locator 2. Go to the Connect menu item and select log on.

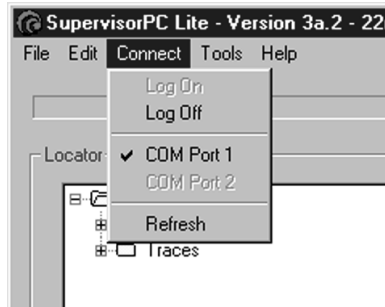

The status bar will indicate that the PC and Locator 2 unit are communicating. Once the communication has completed the Trace and settings headers will be shown on the Locator window.

### 5.5 Downloading traces and settings

In the Locator window of the software expand the relevant category, Settings or Traces. The tree will expand to show all the stored files on the unit. Double click the required file. The file will be downloaded and shown in the relevant window.

### 5.6 Quick printing

To quickly print the downloaded trace or setting go to the file menu and select print screen or settings. This will print to the Windows default printer.

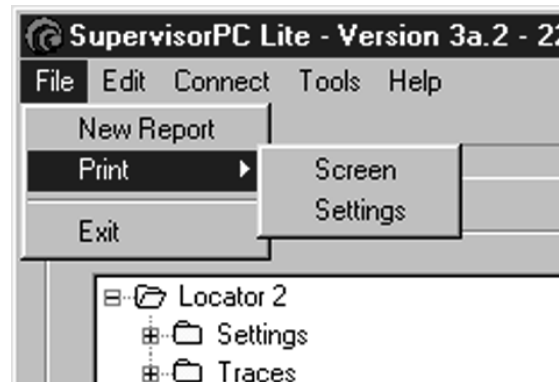

### 5.7 Creating a report

In the File menu select new report. By default this will launch WordPad with a simple template called work.tpl. Move to the Edit menu and choose Copy Trace. This will move the trace to the Windows clipboard. In the WordPad application move the cursor to the appropriate point and choose Paste from the edit menu to insert. Repeat the process for the settings.

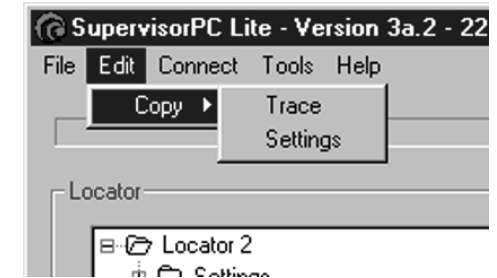
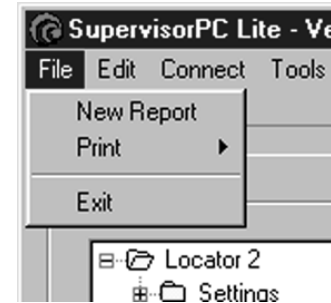

### 5.8 Saving and printing a report

Use the Save As function in the editor to save the file under a different name.

*Note...*

If Save is selected this will write over the report template provided with the SupervisorPC Lite software.

The report can be printed using the print command of the editor.

### 5.9 Changing the default editor and template

If a different editor is required open up the file SuperPC.ini in an appropriate editor. Replace the Wordpad.exe item with the required editor. This .ini file can be found in the root directory that Supervisor PC was installed to.

For a different Template replace the work.tpl item with the file name for the required template.

### 5.10 Restricting Locator 2 Operation

Supervisor PC Lite provides a method for restricting the availability of certain controls. This facility is especially useful when tests are to be carried out by less experienced operators and a supervisor wishes to restrict access to the basic controls.

In user Mode the operator will only be able to look at the Menu and will only be able to change settings that are allocated to the softkeys.

If the Supervisor wishes the operator to recall Traces or Setups then the corresponding files should be set to User Type (see 3.25).

To change the unit to User mode go to the Tools menu and click on User.

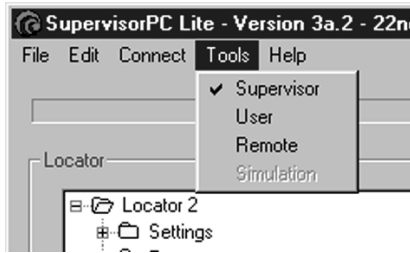

When the User mode is selected the user Icon will appear on the operating screen.



The instrument should now be switched off and disconnected from the RS232 communications cable.

When the unit is switched back on the operator will only have access to the functions provided by the Clear, Balance and Freeze buttons, as well as any functions that have been programmed to the Softkeys.

**Note...**

The unit can only be switched back to Supervisor mode by connection to the SupervisorPC Lite software.

### 5.11 Remote control of Locator 2

Supervisor PC Lite provides a tool for the remote control of Locator 2. Select Tools, Remote and the Remote window will open.

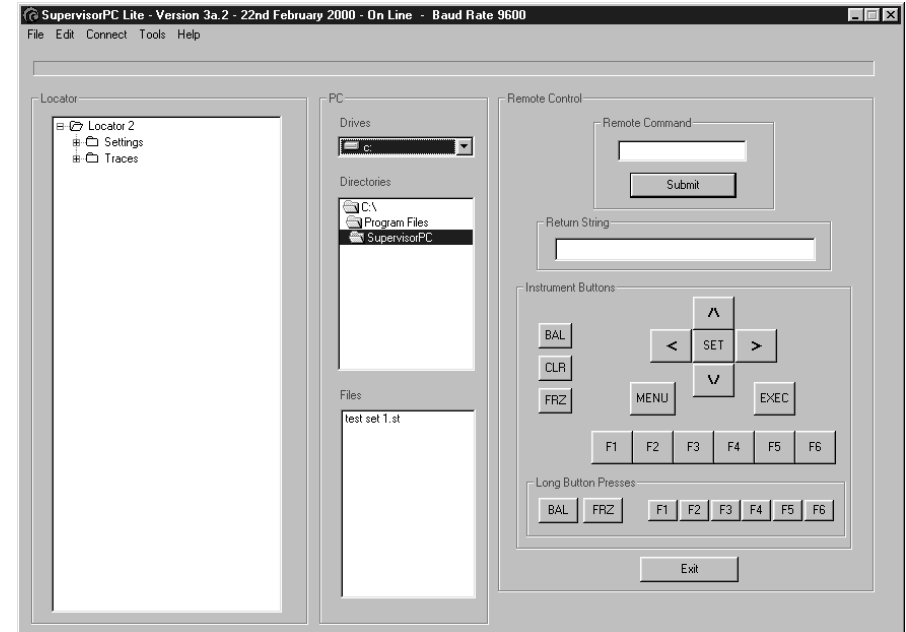

The remote control function operates by the simulated keys on the right hand side of the screen. These can be used in place of the keypad to control the instrument.

Alternatively the remote command line can be used to interrogate the unit and control it. A full set of command strings can be found in the online help.

### 5.12 Using Locator 2 Help

Supervisor PC Lite has an HTML based help file that can be accessed by selecting the Help item. This also include links to external resources that requires a connection to the internet.

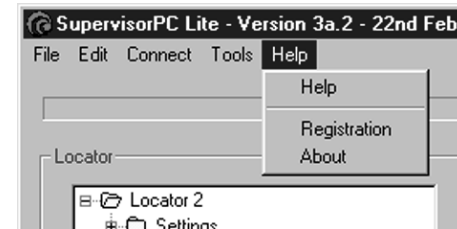

The Help file also provides a place to register ownership of the unit. This will allow updates and bulletins to be sent to the operator that might be of use in the future. Under certain circumstances, such as the issue of further features, registered users may be issued with upgrade software for the unit.

## Chapter 6

### Care and Maintenance

---

#### 6.1 Care and maintenance

Locator 2 is a product of superior design requiring minimum user maintenance.

The suggestions below will help you fulfil any warranty obligations and will keep the Locator 2 fully functional for many years.

- Keep it dry. Precipitation, humidity and most liquids contain minerals that will corrode electronic circuits.
- Do not store in hot or extremely cold areas. Extreme temperatures can shorten the life of electronic devices, damage batteries and warp or melt plastics.
- Do not attempt to open it. Non-expert handling of the device may damage it.
- Do not drop, knock or shake it. Rough handling could break internal circuit boards.
- Do not use harsh chemicals, cleaning solvents or strong detergents to clean it. Wipe it with a soft cloth slightly dampened in a mild soap-and -water solution.
- Do not paint it. Paint can clog the keypad, connectors and battery latching. This will prevent proper operation

---

#### 6.2 Long term storage

As with all battery technologies the lithium-ion battery pack has a shelf life. This means that if the battery pack is left for a long period (greater than 12 months) there is a risk that the voltages inside the unit may drop to a level at which permanent damage to the pack may occur, thus rendering it inoperable.

If the unit is to be left in long term storage the following precautions should be followed:

- Ensure that the storage area is clean and dry. For optimum protection it is recommended that Locator 2 is stored at Room Temperature (i.e. 20° C).
- Make sure that the battery is fully charged and place the battery on the rear of Locator 2.
- It is recommended that all settings and traces are saved and archived on computer using the Supervisor PC Lite program as described in Chapter 5.
- Ensure that the Locator 2 is switched off.
- Visually inspect all items for signs of physical damage.
- Pack Locator 2 and accessories in a protective case and place the Locator 2 kit in a location where it will not be subjected to physical shock or exposed to potentially damaging substances.
- **Every 3 months the Locator 2 should be removed from storage. The lithium-ion battery pack should be removed and charged.**
- When the battery is fully charged place the lithium-ion back on the Locator 2.

## Chapter 7

### Specifications

---

#### Frequencies

100 Hz - 6 MHz in 47 steps. (10 steps/decade with 7 at MHz level)

---

#### Overall Gain

0 dB - 99.9 dB

---

#### Input Gain

Selectable 0 or 20 dB

---

#### Main Gain

Adjustable 10 dB - 80 dB in 0.1, 1 or 10 dB steps

---

#### X:Y Display Ratio

Standard - X:Y = 1:1

Selectable - 16:1, 8:1, 4:1, 2:1, 1:1, 1:2, 1:4, 1:8, 1:16

---

#### Phase

0 - 359.9 Degrees in 0.1, 1 or 10 Deg steps.

---

#### Probe Compatibility

Selectable - Absolute - Locator 100 ohm input

Absolute - Standard 50 ohm input

Differential

Reflection

---

#### Minimum Sensitivity

Instrument readily detects a flaw 0.1 x 0.2 x 0.5 (w x d x h) using a 2MHz Shielded probe

---

#### Internal Balance Loads

1.3, 8.2, 22, 47, 82, 120  $\mu$ H

---

#### Balance Load Selection

Automatic or Manual

---

#### Balance

Push-button automatic

---

#### Lift-off Compensation

Automatic, with Phase rotation to 9 o'clock position, or manual

---

#### Filters

High Pass - DC, Ultra, 1, 2, 5, 10, 20, 50, 100, 200, 500Hz

Low Pass - 3, 5, 10, 20, 30, 50, 75, 100, 200, 300, 500, 750, 1000 Hz

---

#### Display size

Total Viewable 115 x 78 mm

Trace Area 115 x 65

---

#### Display Type

Impedance-Plane display on Transreflective LCD with LED Backlight protected by hard-coated Acrylic window, Pixel pitch 0.2 mm, Useable in ambient lighting from 100 Lux to 7000 Lux

---

#### Display Resolution

480 x 320 pixels

### Display Contrast

Adjustable in 16 steps

### Backlight

Selectable - Low, High, Off

### Graticule

Selectable - Rectangular A, Rectangular B, Polar, None

### Display Modes

Selectable - Spot (X, Y), Timebase (Y/T)

### Timebase Sweep

Selectable - 0.5, 1.0, 2.0, 5.0, 10, 20 Seconds

### Trace Persistence

Selectable - 0.2, 0.5, 1.0, 5.0, 10.0 Seconds

### Spot Position

Adjustable over trace display area

### Alarm Type

**+ and - Y levels** Adjustable from 10% to 90% full screen height

**Box** Adjustable - Left, Right, Top, Bottom

**Sector** Adjustable - Start, End, Inner, Outer

### Alarm Signals

Audio Buzzer and Visual flashing LED

### Buzzer

Selectable - On, Off

### Alarm Stretch

Selectable - 50 mS, 100 mS, 500 mS, 1 Sec, 5 Secs, 10 Secs.

### Operating Modes

'Supervisor Mode' - all functions and adjustments are available at all times.

'User Mode' - limited functions and stored programmes available as selected in the 'Supervisor' mode

### User Controls

Dedicated Tactile buttons for:- Balance, Erase, Freeze large buttons each side for operation by gloved hand

Exec, Menu, Select

On/Backlight-Normal/Backlight-High/Off

Cursor keys for rapid navigation through menu items and settings

'Soft Keys' Six User-Programmable front panel buttons

Note: Keys are arranged for operation by either left or right hand

### Menu Screen

Menu allows all settings to be allocated, saved in memory and recalled. 'Frozen' traces may similarly be saved, named and recalled as required

### Record/Replay Function

Allows recording and replay of up to 14 seconds of inspection data. Settings such as gain and phase may be adjusted to optimise instrument setting and to aid analysis.

### Memory Size

Storage for 50 settings (of all settable parameters) plus 50 traces

### Language

Selectable - English, French, German, Spanish, Portuguese

### Key Click

Selectable - On, Off.

### Keyboard Lock

Selectable - On/Off.

Deactivates all buttons (except Freeze and Power) to avoid inadvertent operation

### Clock

Time and Date up to Year 2099  
(Warranted Y2k Compliant)

### Power Sources

Clip-on sealed Lithium Ion battery pack, securely retained by S/S clip, Gold plated connectors

Clip-on 'AA Cell' battery pack (non IP rated)

Plug in Charger/Battery Eliminator (non IP rated)

### Charge Endurance

13 1/2 hours with backlight OFF, 12 1/2 hours with backlight to NORMAL, 8 1/2 hours with maximum backlight.

Note: Batteries at temperatures below 0°C have reduced capacity

### Charge Indicator

Permanently on-screen, shows proportion of battery charge remaining

### Auto Power Down

Selectable - 5, 10, 15, 20 minutes from last 'keystroke', or permanently ON

### Safety Power-Down

Instrument switches off automatically when battery charge is very low to avoid degraded operation and protect battery pack

### Low-Battery Warning

A 'Low-Battery' alarm sounds 20 minutes before Safety Power-Down

Charger/Battery Eliminator

An 'Intelligent' charger monitors the battery condition and optimises safe recharging. Automatic voltage selection between 90 and 264 VAC, 47-440 Hz. Note: Not IP rated.

### Recharge time

Batteries receive sufficient charge for 6 hours operation in 30 minutes.

Standard full charge takes 3 hours.

Pre-charge may take up to 90 minutes (see 4.2)

Note: No gases are released during charging or discharging.

### Software

Supervisor PC Lite, a Windows based program, allows connection to an external PC for control, setting up, data transfer and printing (Option).

### Serial Interface

Standard RS 232, full Duplex

### Baud Rate

Selectable - 2400, 4800, 9600, 19200, 38400 Baud

### Size

192 mm x 140 mm x 55 mm, ( 7.6 x 5.5 x 2.2 inches) including Lithium Ion battery pack.

---

## Weight

0.94 kg (2 lbs) Including Lithium Ion battery

---

## Temperature Range

Operation from -10° C to +55° C

Storage from -33° C to +71° C

### *Note...*

Prolonged exposure to temperatures over 50°C will reduce battery life

---

## Enclosure

Rated to IP 64, Resistant to short term immersion and/or splash or wipe contact with a wide range of substances including: Avtur/FSII (F34), Avcat (F44), JP8+100 Avgas, 100LL, F18, Diesel, Petrol, Synthetic and mineral based oils, Lotoxane

Tactile moulded rubber grips for non-slip on smooth angled surfaces

---

## Tripod Mount

The enclosure features a standard camera tripod mounting point

---

## Conformance

CE marked. The instrument and accessories conform to appropriate Standards. including EEC Directive 89/336/EEC and 73/23/EEC.

Also approved to UK Def stan 59-4 1 including rigorous tests for non-susceptibility to E Fields in the range 14kHz to 18GHz.

These standards apply when used with appropriate Hocking leads and accessories.

---

## Connectors

Probe - 7 way fixed socket, Lemo Size 1B

Auxiliary - 5 way fixed socket, Lemo Size 0B

Note: Sockets are different sizes to prohibit incorrect connection of cables.

Sockets are secured from rear to reduce risk

**58** Foreign Object Damage

# Chapter 8

## Accessories

| PRN           | Description   |
|---------------|---|
| <b>39I002</b> | <b>Locator 2, Portable Eddy Current Flaw Detector</b>                           |
| <b>39A001</b> | Lead, for Absolute probe, Lemo 7 way to Microtech 1.5 metre.                    |
| <b>39A002</b> | Lead, for Absolute probe, Lemo 7 way to BNC 1.5 metre.                          |
| <b>39A003</b> | Adapter, for Absolute BNC lead, Lemo 7 way to BNC.                              |
| <b>39A004</b> | Lead, Hocking Bridge Lemo 7 way to Lemo 4 way 1.5 metre.                        |
| <b>39A005</b> | Lead, Hocking Reflection Lemo 7 way to Lemo 4 way 1.5 metre.                    |
| <b>39A007</b> | Adapter, Lemo 7 way to Din 5 way Defectometer..                                 |
| <b>39A008</b> | Adapter, Lemo 7 way to 2 x BNC.   |
| <b>39A009</b> | Lead, Rohmann Bridge Lemo 7 way to Fischer 4 way 1.5 metre.                     |
| <b>39A010</b> | Lead, Rohmann Reflection Lemo 7 way to Fischer 4 way 1.5 metre.                 |
| <b>39A011</b> | Lead, Lemo 7 way to Lemo 2 way Super Halec Reflection.                          |
| <b>39A012</b> | Lead, Lemo 7 way to DIN 7 way, Alcoprobe Reflection.                            |
| <b>39A013</b> | Adapter, Lemo 7 way to DIN 7 way, Alcoprobe Reflection.                         |
| <b>39A014</b> | Adapter, Lemo 7 way to Jaeger 6 way.  |
| <b>39A015</b> | Adapter, Lemo 7 way to Burndy Nortec.   |
| <b>39A016</b> | Adapter, Zetec Bridge, Lemo 7 way to Amphenol 4 way.                            |
| <b>39A017</b> | Adapter, Zetec Reflection, Lemo 7 way to Amphenol 4 way                         |
| <b>39A018</b> | Adapter, Rohmann reflection Lemo 7 way to Fischer 8way.                         |
| <b>39A019</b> | Adapter, Lemo 7 way to Veam 15 way, Forster.                                    |
| <b>39A020</b> | Lead, Lemo 7 way to Lemo 5 way, Forster Reflection.                             |
| <b>39A021</b> | Lead, Lemo 7 way to 2 x Microtech, Differential Beadseat.                       |
| <b>39A023</b> | Output Power lead for Charger/Eliminator to Locator 2                           |
| <b>39A024</b> | RS232 Lead  |
| <b>39A025</b> | Earpiece and Lemo 5 way connector for Audio output from Locator 2               |
| <b>39A030</b> | Lithium-ion battery pack.   |
| <b>39A031</b> | AA/Battery eliminator pack.   |
| <b>39A035</b> | Battery Charger/Eliminator Unit.  |
| <b>39A038</b> | Locator 2 Communication Software.   |
| <b>39A039</b> | Tripod stand for Locator 2.   |
| <b>39A040</b> | Lightweight operating handle for Locator 2                                      |
| <b>39A041</b> | Splashproof case with plastic front for operation of Locator 2 (see Fig 8.2)    |
| <b>39A042</b> | Locator 2 Soft Pouch for storage, accepts charger (see Fig 8.1)                 |
| <b>39A043</b> | Rugged Polycarbonate Transit case (see Fig 8.4)                                 |
| <b>39A044</b> | Compact Locator 2 Soft Pouch for storage, does not accept charger (see Fig 8.3) |
| <b>39DH01</b> | Locator 2 Owners Manual.  |



8.1

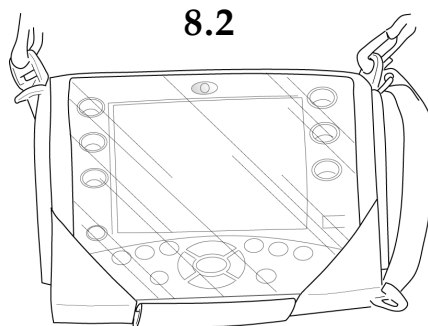

8.2



8.3

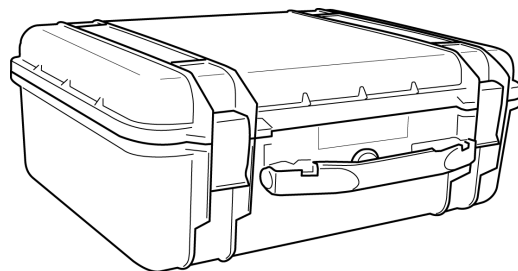

8.4

(for descriptions and Product Reference numbers see previous page).

## Chapter 9

### Glossary

- A -

#### **ABSOLUTE PROBE**

A probe where only one coil is used to test the material. A balancing coil may be present in the instrument or within the probe body. For Locator 2 the nominal impedance is 50 ohms. Also see Locator.

#### **AC**

An abbreviation for alternating current as used in the domestic power supply and eddy current probe excitation.

#### **ALPHANUMERIC**

Indicating either alphabetic letters or numerals.

#### **AMPLIFICATION**

This is a measure of the increase in level of the probe signal before a representation of it appears on the display. On the menu, it is also described as Gain and is usually measured in dB. E.g +6dB = 2x gain, -6dB = 1//2x gain, +20dB = 10x gain and -20dB = 1/10x gain

- B -

#### **BALANCE LOAD**

An inductance added to the instruments input circuit to allow the use of absolute single coil probes. The value of the inductance should equal that of the absolute probe. Also see HENRY and INDUCTANCE.

#### **BALANCING**

This facility allows steady or dc signals from a probe, or probe/material combination, to be cancelled out. The visual effect is that after balancing has occurred the display is set at zero or a preset reference point.

#### **BAUD**

Baud Rate is the number of bits of information transmitted in one second.

#### **BRIDGE**

A probe connection where there are two coils connected so that the signal is compared between them.

- C -

#### **CURRENT**

Is the measure of the amount of electrical charge flowing in a conductor in unit time. Unit of measurement the Ampere (A)

- D -

#### **dB**

An abbreviation for decibels, a logarithmic measure of gain or attenuation. See AMPLIFICATION

**DC**

An abbreviation for direct current as supplied by a battery.

**DEFECT**

An imperfection in material composition.

**DIFFERENTIAL**

A differential probe is one that has two detection coils arranged such that equal signals detected by both coils are cancelled out. This gives much less drift and noise than an absolute probe. May be Bridge or Reflection connected.

**DIGITAL**

Digital or logic circuitry operates in incremental steps and switches between two voltage levels (commonly 0V and +5V). A microprocessor consists of digital circuitry.

**DSP**

Digital Signal Processor. A specialised type of microprocessor, it is optimized for high speed processing of digitized signals, used for phase rotation, filtering, mixing etc.

**- E -****EARTH**

A local connection between a circuit or device and the earth which is at zero potential.

**EDDY CURRENT**

These are the currents that are created in a conductive material when changing magnetic fields intersect the conductor. e.g. by bringing a coil carrying an alternating current near to the conductive material. Commonly used to describe the Non-Destructive testing method exploiting this phenoema.

**EC**

An abbreviation for Eddy Current.

**ET**

Electro-magnetic testing. An alternative term used in the USA for Eddy Current Testing.

**- F -****f, Freq.**

Abbreviation for Frequency. Unit Hertz (Hz)

**FILTER**

Is an electronic device for limiting frequency range. Filters are often described as high, low or band pass.

**FLAW**

An imperfection in material composition eg. a crack.

**FREQUENCY**

For an alternating current signal, frequency is a measure of the number of full cycles occurring every second (measured in Hertz).

**- G -****GAIN**

See AMPLIFICATION

**GROUND**

An alternative word for EARTH, a local connection between a circuit or device and the earth which is at zero potential.

**GROUNDING**

The act of connecting to ground.

**- H -****HERTZ**

Unit of frequency. Abbreviated to Hz

**Hz**

Abbreviation for Hertz. 1 kHz = one thousand Hz and 1 MHz = one million Hz

**- I -****IMPEDANCE**

Circuits that have resistive and reactive components (capacitance and inductance are reactive components) are said to give an impedance to the flow of current. Impedance is normally dependent on frequency.

**INDUCTANCE**

Inductance is a measure of the voltage required to cause current to change at a given rate in a coil of wire. Measured in Henrys. Usually in micro-henries (millionths of a Henry) = uH

**- L -****LED**

Abbreviation for light emitting diode.

**LCD**

Abbreviation for Liquid Crystal Display.

**Li-Ion**

Abbreviation for Lithium Ion battery technology. Offering high charge density, zero memory effect and greater charge cycle life. Also see NiMH and NiCd. State of the art technology.

**LIFT-OFF**

The signal caused when a probe is lifted from the test specimen surface. Can refer to movement or the actual spacing.

**LIFT-OFF COMPENSATION**

Setting the phase of the signal caused by lift-off to the 9 o'clock direction from the balnce point in order to ensure that defect signals in the Y axis are relatively free of this effect.

**LOCATOR PROBE**

As in Locator Probe. This is an absolute probe but to be compatible with the Locator UH the nominal impedance is 100 ohm. This means that the operating frequency for a Locator Probe when set to Absolute Probe Mode is half that when set to Locator Probe Mode e.g. 2Mhz probe may be used at 1Mhz in absolute probe mode. See Absolute Probe.

- *N* -

**NDE**

Abbreviation for NON DESTRUCTIVE EVALUATION

**NDT**

Abbreviation for NON DESTRUCTIVE TESTING

**NiCd or NICAD**

Abbreviation for Nickel-Cadmium technology batteries. Well known for suffering from the memory effect, where the energy storage capability is reduced if the battery is not discharged fully before recharging. Oldest of battery technology used in portable equipment.

**NiMH**

Abbreviation for Nickel Metal Hydride battery technology. Successor to NiCd giving no memory effect at the cost of a higher self discharge rate.

**NOISE**

Unwanted signals which appear on the display. Much of the design work for an eddy current instrument is involved with minimising electronic noise (both external and internal) in order to improve the signal to noise ratio.

- *P* -

**PROBE**

This is the name given to hand held eddy current sensors. See also ABSOLUTE, LOCATOR, DIFFERENTIAL, BRIDGE and REFLECTION.

- *R* -

**REFLECTION**

A probe connection where there is a primary and secondary windings. The secondary output is connected so as to give a small output. May be differential or absolute.

**RS232**

A serial communications protocol for transferring data between computers and other devices.

- *S* -

**SKIN EFFECT**

The tendency for alternating current to flow near the surface of a conductor.

**SKIN DEPTH**

The average depth at which an eddy current is considered to flow (37% of the current density at the surface) and decreases exponentially with depth. Higher frequencies, relative permeability (magnetism) and conductivity result in less skin depth.

- *T* -

**THRESHOLD**

A limit which indicates that the signal from a defect is sufficient to cause concern.

**TRAIN**

To train an instrument is to set the phase angle to optimum for the sample under test (term used on Hocking Locator UH). The equivalent of Auto Lift-Off on Locator 2.

Locator 2 Owners Manual

Hocking NDT Ltd  
129-135 Camp Road  
St Albans  
Herts. AL1 5HL

Tel +44 (0)1727 795544  
Fax: +44 (0)1727 795444

Email: [info@hocking.com](mailto:info@hocking.com)  
[www.hocking.com](http://www.hocking.com)  
[www.locator2.com](http://www.locator2.com)

Drawing No: 45942-A  
Doc Ref: 39DH01  
Handbook ver 05  
Sep 2000

j:\m\pl2\doc\op man\ver 05 sep\loc2manver05